

Varenummer: 20478B20M8ELS
 Beskrivelse: E+G Rørholder - GN 478-B20-M8-ELS

Mål

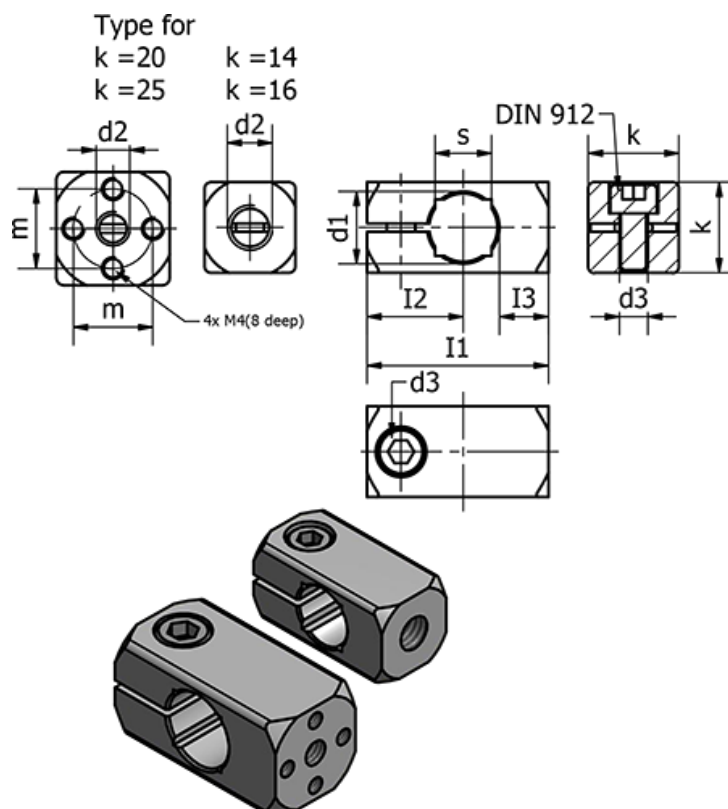

d1 h11	= 20	m	= 17
d2	= M8	s	= 16
d3	= M6	Vægt (g)	= 51
Fastspændings kit for d2 = GN 511-M6-25			
I1	= 45		
I2	= 21.5		
I3	= 12		
k	= 25		